

LICENSE & BACK-UP LIGHTS

LICENSE LIGHTS

Pages 182-190

LED

SERIES	COMMON SIZE	PAGES
15® Series	1" x 2"	182
33® Series	0.75"	183
36 Series	1" x 2"	184

INCANDESCENT

SERIES	COMMON SIZE	PAGES
15® Series	1" x 2"	185
17 Series	2"	185-186
19® Series	2"	186
21® Series	2" x 6"	187
Super 21®	2" x 6"	187-188
26 Series	1"	188-189
Signal-Stat	Multiple	190

LED

SERIES	COMMON SIZE	PAGES
Super 44®	4"	191-195
Signal-Stat	4"	195-196
66 Series	2" x 6"	196
Signal-Stat Oval	2" x 6"	197
Signal-Stat Rectangular	3" x 5"	197

INCANDESCENT

SERIES	COMMON SIZE	PAGES
40® Series	4"	198-199
Super 40®	4"	200
45® Series	3" x 5"	201
Super 45®	3" x 5"	201
60® Series	2" x 6"	202
60® Economy	2" x 6"	203
80 Series	4"	203-204
1 Bulb 4in	4"	204-205
Signal-Stat 1 Bulb 4in	4"	205
1 Bulb 2in x 6in	2" x 6"	206
1 Bulb 4in x 6in	4" x 6"	206







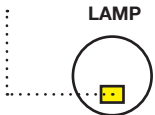
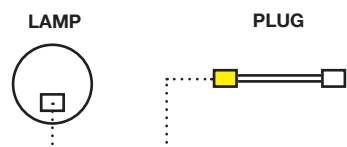
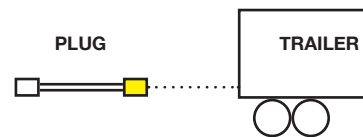





License & Back-Up Lights

Introduced originally by Truck-Lite, these bright, dependable LED back-up and license lighting and space-saving combination lamps come in a variety of shapes and sizes.

<p>Shapes</p>	<p>Round, Oval, Rectangular</p>
<p>Mount Types</p>	<p>Grommet, Flange, 2 Screw, 4 Screw, Adhesive</p>
<p>Connection Information</p> <p>When it comes to choosing the correct lamps for your truck or trailer, it's important to know the connection type on your vehicle's harness.</p> <p>If the harness connector type does not match your desired light (lamp connector), you will need a plug to complete the connection.</p>	<p>Lamp Connector</p> <p>The connector type located on the back of a lamp</p>  <p>Plug Side 1</p> <p>The connection between a plug and a lamp</p>  <p>Plug Side 2</p> <p>The connection between a plug and a trailer's harness</p> 

(800) 562-5012 | truck-lite.com

 <p>Manufacturing & Quality</p>	 <p>Testing & Safety</p>
<p>Truck-Lite’s LED license and back-up lighting is built using premium materials and backed by industry-leading warranties.</p> <p>Designed to last the life of your vehicle, Truck-Lite’s solid-state construction and sealed circuitry mean that you can depend on your lighting to withstand shock, vibration, moisture and debris.</p>	<p>All Truck-Lite lamps are subjected to rigorous environmental, electrical and mechanical testing before they are validated and released to the market.</p> <p>All lamps comply with FMVSS/CMVSS-108, SAE and DOT standards when properly mounted.</p>
 <p>Performance & Maintenance</p>	 <p>Customer Support</p>
<ul style="list-style-type: none"> • Lower energy consumption • Impact-resistant, non-yellowing lenses and rugged housing protect against damage from even the toughest applications • Robust, cost-effective design 	<p>Customer Service</p> <p> (800) 562-5012 customerservice@truck-lite.com</p> <p>Technical Support</p> <p> (888) 562-5012 tltech@truck-lite.com</p> <p>License/BU Light Warranties</p> <div style="display: flex; justify-content: space-around; align-items: center;">      </div>
<p>(800) 562-5012 truck-lite.com</p>	

15[®] SERIES, LED, 3 DIODE, 1"x2", BRACKET MOUNT

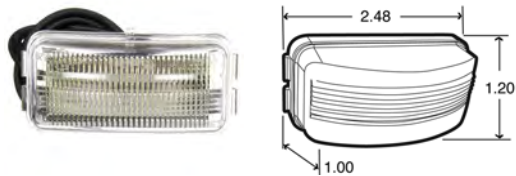

- Meets SAE J587 and European ECE Regulations 4
- Hardwired design with adapter plug for quick changeover without rewiring
- Functions as utility lamp or license lamp when properly mounted using license plate brackets #00820, #15729, #15730, #15732 or #15736

Part Number	Lamp Connector	Plug Side 1	Plug Side 2	Lens Color	Lens Material	Volts	Amps
15905	Hardwired	Hardwired	Stripped End	Clear	PC	24	0.03
15205	Hardwired	Hardwired	Female PL-10	Clear	PC	12	0.03
15226	Hardwired	Hardwired	Female PL-10	Clear	PC	12	0.03
15227	Hardwired	Hardwired	.180 Bullet	Clear	PC	12	0.03

15[®] SERIES, LED, 3 DIODE, 1"x2", BRACKET MOUNT, KIT

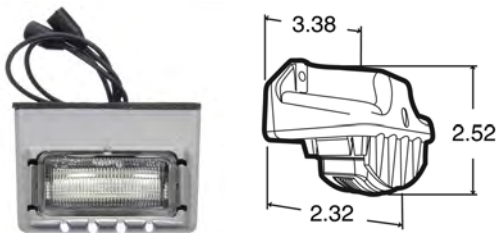

- Meets SAE J587 and European ECE Regulations 4
- Hardwired design w/ adapter plug for quick changeover without rewiring
- Functions as utility lamp or license lamp when properly mounted using license plate brackets #00820, #15729, #15730, #15732 or #15736

Part Number	Lamp Connector	Plug Side 1	Plug Side 2	Lens Color	Lens Material	Mount Color	Volts	Amps	Kit Includes
15040	Hardwired	Hardwired	Female PL-10	Clear	PC	Gray	12	0.03	15205 light, 15729 bracket mount, 97032 gasket
15041	Hardwired	Hardwired	Female PL-10	Clear	PC	Black	12	0.03	15205 light, 15730 bracket mount, 97032 gasket
15042	Hardwired	Hardwired	Stripped End	Clear	PC	Gray	24	0.03	15905 light, 15729 bracket mount, 97032 gasket
15043	Hardwired	Hardwired	Stripped End	Clear	PC	Black	24	0.03	15905 light, 15730 bracket mount, 97032 gasket
15053	Hardwired	Hardwired	Female PL-10	Clear	AC	Gray	12	0.03	15226 light, 15729 bracket mount, 97032 gasket
15054	Hardwired	Hardwired	.180 Bullet	Clear	PC	Gray	12	0.03	15227 light, 15729 bracket mount, 97032 gasket
15055	Hardwired	Hardwired	Female PL-10	Clear	PC	Chrome	12	0.03	15205 light, 15732 bracket mount, 97032 gasket
15056	Hardwired	Hardwired	Stripped End	Clear	PC	Chrome	24	0.03	15905 light, 15732 bracket mount, 97032 gasket
15058	Hardwired	Hardwired	.180 Bullet	Clear	PC	Black	12	0.03	15227 light, 15730 bracket mount, 97032 gasket
15059	Hardwired	Hardwired	Female PL-10	Clear	PC	Chrome	12	0.03	15226 light, 15732 bracket mount, 97032 gasket
15060	Hardwired	Hardwired	.180 Bullet	Clear	PC	Chrome	12	0.03	15227 light, 15732 bracket mount, 97032 gasket
15061	Hardwired	Hardwired	Female PL-10	Clear	PC	Black	12	0.03	15226 light, 15730 bracket mount, 97032 gasket

33[®] SERIES, LED, 1 DIODE, 0.75", GROMMET MOUNT



- Hardwired lamp design is easily retrofitted, with only a 1-3/16" mounting hole required for grommet installation
- US Patent 5,943,798
- Product designed to fit in 33705 grommet
- Top and side plate mounting options
- When mounted into a module, all wires are hidden inside module, protecting against damage from corrosion
- Does not require a bracket, so it can be mounted directly into the vehicle
- Stealth, low-profile design is resistant to damage, and hides lamp away from view to help prevent theft
- LEDs draw less current, allowing more power for other vehicle requirements
- Reduces lighting costs due to physical damage and heat entrapment
- Electronics are completely sealed in epoxy to resist corrosion and moisture

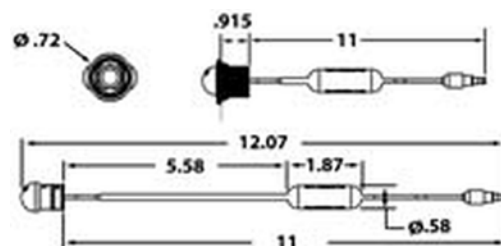

Part Number	Lamp Connector	Plug Side 1	Plug Side 2	Lens Color	Lens Material	Mount Color	Volts	Amps
33210C	Hardwired	Hardwired	.180 Bullet	Clear	PC		12	0.15

33[®] SERIES, LED, 1 DIODE, 0.75", GROMMET MOUNT, KIT



- Hardwired lamp design is easily retrofitted, with only a 1-3/16" mounting hole required for grommet installation
- US Patent 5,943,798
- Product designed to fit in 33705 grommet
- Top and side plate mounting options
- When mounted into a module, all wires are hidden inside module, protecting against damage from corrosion
- Does not require a bracket, so it can be mounted directly into the vehicle
- Stealth, low-profile design is resistant to damage, and hides lamp away from view to help prevent theft
- LEDs draw less current, allowing more power for other vehicle requirements
- Reduces lighting costs due to physical damage and heat entrapment
- Electronics are completely sealed in epoxy to resist corrosion and moisture

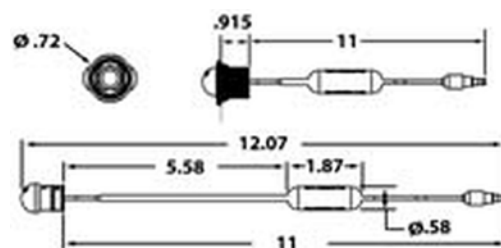

Part Number	Lamp Connector	Plug Side 1	Plug Side 2	Lens Color	Lens Material	Mount Color	Volts	Amps	Kit Includes
33010C	Hardwired	Hardwired	.180 Bullet	Clear	PC	Black	12	0.15	33210C light, 33705 grommet

LED

36 SERIES

36 SERIES, LED, 3 DIODE, 1"X2", ADHESIVE MOUNT

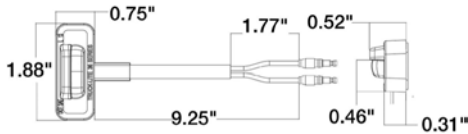

- Provides license lamp solution that requires no mounting brackets or installation screws
- Lamp adheres directly to mounting surface through use of heavy-duty adhesive backing, with an easy-to-install, peel-off liner
- OmniVolt
- Hardwired with rear and side exit wires complete with .180 molded bullets
- Can be mounted without any mounting brackets or fasteners
- LEDs draw much less current and are rated at 100,000 hours
- Electronics are completely sealed in epoxy to resist damage caused by moisture, corrosion, shock and vibration
- When properly mounted the lamps are designed to conform to the applicable requirements of FMVSS - 108



Part Number	Lamp Connector	Plug Side 1	Plug Side 2	Lens Color	Lens Material	Mount Color	Volts	Amps
36145C	Hardwired	Hardwired	.180 Bullet	Clear	PC	Black	12 24	0.05
36140C	Hardwired	Hardwired	.180 Bullet	Clear	PC	Black	12 24	0.05

LED

36 SERIES

36 SERIES, LED, 3 DIODE, 1"X2", ADHESIVE MOUNT, KIT

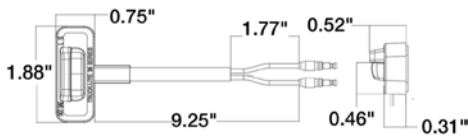

- Provides license lamp solution that requires no mounting brackets or installation screws
- Lamp adheres directly to mounting surface through use of heavy-duty adhesive backing, with an easy-to-install, peel-off liner
- OmniVolt
- Hardwired with rear and side exit wires complete with .180 molded bullets
- Can be mounted without any mounting brackets or fasteners
- LEDs draw much less current and are rated at 100,000 hours
- Electronics are completely sealed in epoxy to resist damage caused by moisture, corrosion, shock and vibration
- When properly mounted the lamps are designed to conform to the applicable requirements of FMVSS - 108



Part Number	Lamp Connector	Plug Side 1	Plug Side 2	Lens Color	Lens Material	Mount Color	Volts	Amps	Kit Includes
36041C	Hardwired	Hardwired	.180 Bullet	Clear	PC	Gray	12 24	0.05	36140C light, 36710 bracket
36042C	Hardwired	Hardwired	.180 Bullet	Clear	PC	Black	12 24	0.05	36140C light, 36711 bracket

15[®] SERIES, INCANDESCENT, 1 BULB, 1"x2", BRACKET MOUNT

- High-impact polycarbonate, sonically sealed lens and housing
- Available in 12 or 24-volt versions
- Features 15,000-hour-long life 12v bulb
- Must be used with Model 15 mounting brackets
- Replaces Signal-Stat 1502W
- Upgrade to LED lighting systems using Truck-Lite's 15 Series LED license lamps

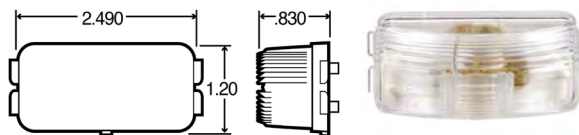

Part Number	Lamp Connector	Lens Color	Lens Material	Volts	Amps
15208	PL-10	Clear	PC	12	0.33
15209	PL-10	Clear	PC	24	0.17

INCANDESCENT

15 SERIES

15[®] SERIES, INCANDESCENT, 1 BULB, 1"x2", BRACKET MOUNT, KIT



- Features snap-fit mount for quick installation and easy replacement
- Bracket may be surface mounted

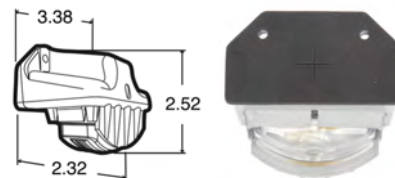

Part Number	Lamp Connector	Lens Color	Lens Material	Mount Color	Volts	Amps	Kit Includes
15011	PL-10	Clear	PC	Gray	12	0.33	15208 light, 15729 bracket, 97032 grommet
15012	PL-10	Clear	PC	Black	12	0.33	15208 light, 15730 bracket, 97032 grommet
15013	PL-10	Clear	PC	Chrome	12	0.33	15208 light, 15732 bracket, 97032 grommet

INCANDESCENT

15 SERIES

17 SERIES, INCANDESCENT, 1 BULB, 2", 2 SCREW



- High-impact polycarbonate, sonically sealed lens and housing
- Designed to mount with bracket, #17720
- Horizontal mount only

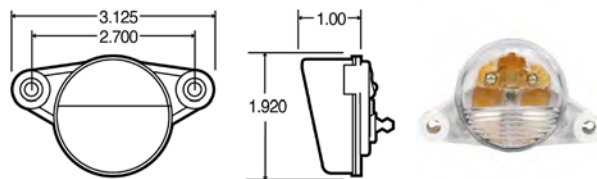

Part Number	Lamp Connector	Lens Color	Lens Material	Mount Color	Volts	Amps
17200	License Lamp Plug	Clear	PC	Gray	12	0.33

INCANDESCENT

17 SERIES

17 SERIES, INCANDESCENT, 1 BULB, 2", 2 SCREW, KIT

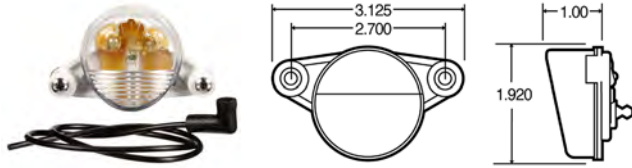

- High-impact polycarbonate, sonically sealed lens and housing
- Designed to mount with bracket, #17720
- Horizontal mount only



Part Number	Lamp Connector	Plug Side 1	Plug Side 2	Lens Color	Lens Material	Mount Color	Volts	Amps	Kit Includes
17001	License Lamp Plug	Right Angle License Lamp Plug	Blunt Cut	Clear	PC	White	12	0.33	17200 light, 94922 plug
17002	License Lamp Plug	Straight License Lamp Plug	Blunt Cut	Clear	PC	White	12	0.33	17200 light, 94923 plug

17 SERIES, INCANDESCENT, 1 BULB, 2", BRACKET MOUNT, KIT

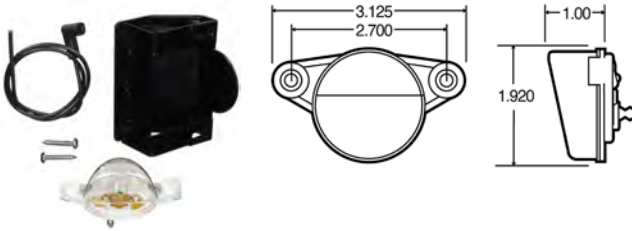

- High-impact polycarbonate, sonically sealed lens and housing
- Designed to mount with bracket, #17720
- Horizontal mount only



Part Number	Lamp Connector	Plug Side 1	Plug Side 2	Lens Color	Lens Material	Mount Color	Volts	Amps	Kit Includes
17003	License Lamp Plug	Right Angle License Lamp Plug	Blunt Cut	Clear	PC	Black	12	0.33	17200 light, 94922 plug

19[®] SERIES, INCANDESCENT, 2 BULB, 2", BRACKET MOUNT, KIT

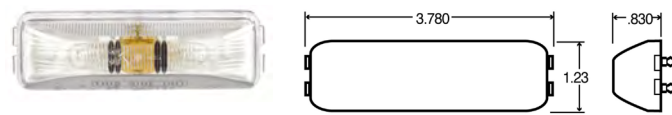

- Fruehauf replacement lamp
- High-impact polycarbonate, sonically sealed lens and housing
- Long-life, 15,000-hour bulbs
- License or utility applications
- Replaces Signal-Stat 1901W



Part Number	Lamp Connector	Lens Color	Lens Material	Volts	Amps
19206	19 Series Male Pin	Clear	PC	12	0.33

INCANDESCENT

17 SERIES

INCANDESCENT

17 SERIES

INCANDESCENT

19 SERIES

21[®] SERIES, INCANDESCENT, 2 BULB, 2"x6", 2 SCREW



- Features male pin connections
- Polycarbonate lens and housing withstands impact and corrosion
- Shock mount absorbs road shock and vibration
- Replaces Grote #60331

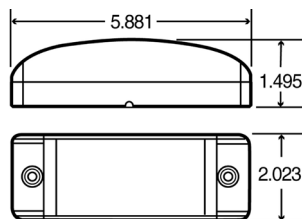

Part Number	Lamp Connector	Lens Color	Lens Material	Mount Color	Volts	Amps
29204C	Male Pin	Clear	PC	Clear	12	0.33

INCANDESCENT

21 SERIES

21[®] SERIES, INCANDESCENT, 2 BULB, 2"x6", 2 SCREW, KIT



- Features male pin connections
- Polycarbonate lens and housing withstands impact and corrosion
- Shock mount absorbs road shock and vibration
- Replaces Grote #60331

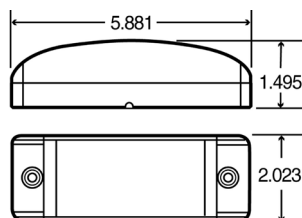

Part Number	Lamp Connector	Plug Side 1	Plug Side 2	Lens Color	Lens Material	Mount Color	Volts	Amps
29004C	Male Pin	Male Pin	.180 Bullet Ring Terminal	Clear	PC	Clear	12	0.33

INCANDESCENT

21 SERIES

SUPER 21[®], INCANDESCENT, 1 BULB, 2"x6", 2 SCREW



- Acrylic lens and ABS housing are sonically sealed
- Unique bulb cradle shock mount absorbs shock and vibration, prolonging bulb life
- Long life bulb is rated for 15,000 hours
- Lamp kit includes #96930 hot wire

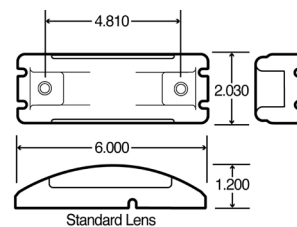

Part Number	Lamp Connector	Lens Color	Lens Material	Mount Color	Volts	Amps
21204C	Super 21 Plug	Clear	AC	Clear	12	0.33

INCANDESCENT

SUPER 21 SERIES

SUPER 21[®], INCANDESCENT, 1 BULB, 2"x6", 2 SCREW, KIT

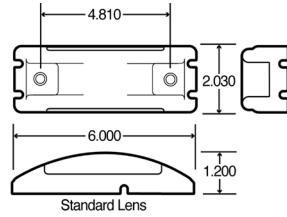

- Acrylic lens and ABS housing are sonically sealed
- Unique bulb cradle shock mount absorbs shock and vibration, prolonging bulb life
- Long-life bulb is rated for 15,000 hours
- Lamp kit includes #96930 hot wire



Part Number	Lamp Connector	Plug Side 1	Plug Side 2	Lens Color	Lens Material	Mount Color	Volts	Amps	Kit Includes
21004C	Super 21 Plug	Super 21 Plug	Stripped End	Clear	AC	Clear	12	0.33	21004C light, 96930 plug

26 SERIES, INCANDESCENT, 1 BULB, 1", GROMMET MOUNT, ROUND

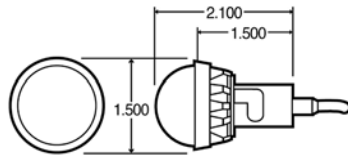

- Features chrome-plated brass housing
- Snap-fit design uses standard 1-1/4" diameter hole
- Commonly used to illuminate a license plate on step bumpers
- Two units required for license illumination
- Ideal for courtesy, map, instrument, license or step lighting
- Snaps securely into any panel thickness up to .187"
- Replaces Signal-Stat 430W



Part Number	Lamp Connector	Plug Side 1	Plug Side 2	Lens Color	Lens Material	Mount Color	Volts	Amps
26331	Hardwired	Hardwired	.180 Bullet	Clear	PC	Chrome	12	0.59

26 SERIES, INCANDESCENT, 1 BULB, 1", 2 SCREW, ROUND

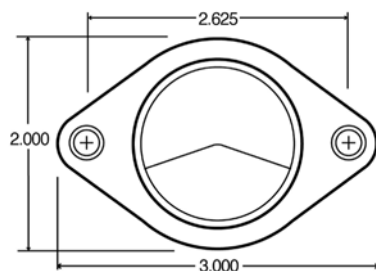

- Features a chrome-plated steel lens shade
- Design is similar to lamps used on GM vehicles
- Two lamps required for license plate illumination
- Rubberized, single-contact electrical plug
- Replaces Signal-Stat 436W



Part Number	Lamp Connector	Plug Side 1	Plug Side 2	Lens Color	Lens Material	Mount Color	Volts	Amps
26336	Hardwired	Hardwired	.156 Bullet	Clear	PC	Chrome	12	0.59

INCANDESCENT

SUPER 21 SERIES

INCANDESCENT

26 SERIES

INCANDESCENT

26 SERIES

26 SERIES, INCANDESCENT, 1 BULB, BRACKET MOUNT, KIT



- Features high-impact housing with aerodynamic design
- Mounts on 1-3/4" hole centers
- Replaces Signal-Stat 420W and 423W

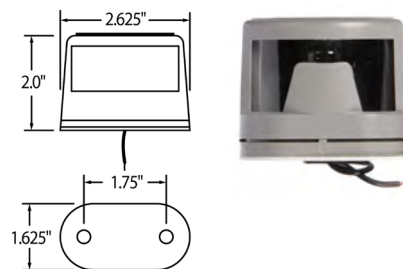

Part Number	Lamp Connector	Plug Side 1	Plug Side 2	Lens Color	Lens Material	Mount Color	Volts	Amps	Kit Includes
26335	Hardwired	Hardwired	Stripped End	Clear	PC	Gray	12	0.59	26380 hood

INCANDESCENT

26 SERIES

26 SERIES, INCANDESCENT, 1 BULB, 2 SCREW BRACKET MOUNT



- Extra-rugged cadmium-plated steel housing
- Screw lock cover cams on/off for easy bulb replacement
- Ideal for license, instrument or step lighting
- Surface mounts, grounds through screw
- Replaces Signal-Stat 431W
- 1/4" screw hole diameter

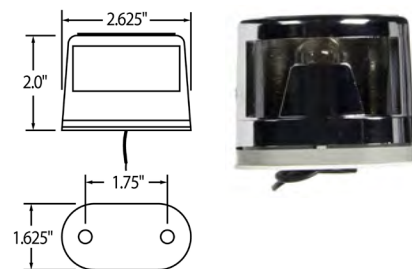

Part Number	Lamp Connector	Plug Side 1	Plug Side 2	Lens Color	Lens Material	Mount Color	Volts	Amps
26330	Hardwired	Hardwired	Stripped End	Clear	PC	Chrome	12	0.59
26371	Hardwired	Hardwired	Stripped End	Clear	PC	Black	12	0.59

INCANDESCENT

26 SERIES

Keep Your Connections Safe. Don't Forget Your Dielectric Gel.

Dielectric gel protects your lights by protecting the points of contact between elements of your lighting and harness system. Our dielectric compounds prevent arcing and corrosion and keep your lights performing as they should.

You can find our dielectric products on page 498



INCANDESCENT

SIGNAL-STAT

SIGNAL-STAT, INCANDESCENT, 1 BULB, 1"X2", BRACKET MOUNT, KIT, RECTANGULAR

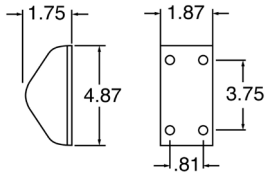

- Aluminum or gray-painted steel housing
- Fully protected lens with high guard
- Pressure pad tightly seals lens
- Quick-click lens removal



Part Number	Lamp Connector	Plug Side 1	Plug Side 2	Lens Color	Lens Material	Mount Color	Volts	Amps
1105W	Hardwired	Hardwired	Stripped End	Clear	PC	Gray	12	0.35

INCANDESCENT

SIGNAL-STAT

SIGNAL-STAT, INCANDESCENT, 1 BULB, 2"X6", 2 SCREW BRACKET MOUNT, RECTANGULAR

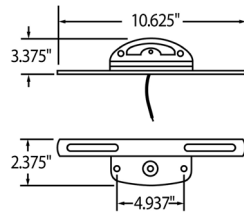

- Original equipment on Airstream
- Chrome-plated steel lamp body
- Rubber pad between lamp and frame



Part Number	Lamp Connector	Plug Side 1	Plug Side 2	Lens Color	Lens Material	Mount Color	Volts	Amps
435W	Hardwired	Hardwired	Stripped End	Clear	AC	Chrome	12	0.59

INCANDESCENT

SIGNAL-STAT

SIGNAL-STAT, INCANDESCENT, 1 BULB, 1"X3", 2 SCREW BRACKET MOUNT, TRIANGULAR

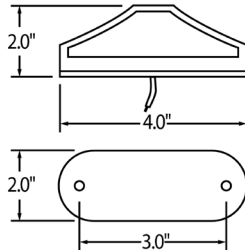

- Snap-grip lens hood for easy bulb replacement
- Ideal for license, instrument or step lighting
- Surface mount, grounds through screw
- Permastat housing will not rust
- Wire length 7 1/2"



Part Number	Lamp Connector	Plug Side 1	Plug Side 2	Lens Color	Lens Material	Mount Color	Volts	Amps
425WD	Hardwired	Hardwired	Stripped End	Clear	PC	Gray	12	0.59
426W	Hardwired	Hardwired	Stripped End	Clear	PC	Chrome	12	0.59

SUPER 44[®], LED, 6 DIODE, 4", GROMMET MOUNT



- Features robust, cost-effective, efficient design
- Surpasses back-up specifications with one-lamp, eliminating two-lamp systems
- Resembles Super 44 Series S/T/T lamp diode appearance for consistent look
- Epoxy-encapsulated with exclusive Fit 'N Forget™ plug assembly keeps corrosives away from lamp
- Not recommended for dome lamp use
- U.S. Registered TM #3483147



Part Number	Lamp Connector	Lens Color	Lens Material	Volts	Amps	Diamond Shell
44990C	Fit 'N Forget S.S.	Clear	AC	12	0.53	Yes
44350C	Fit 'N Forget S.S.	Clear	PC	12	0.53	No

LED

SUPER 44

SUPER 44[®], LED, 6 DIODE, 4", GROMMET MOUNT, HARDWIRED



- Features robust, cost-effective, efficient design
- Surpasses back-up specifications with 1 lamp, eliminating 2 lamp systems
- Resembles Super 44 Series S/T/T lamp diode appearance for consistent look
- Epoxy-encapsulated with exclusive Fit 'N Forget™ plug assembly keeps corrosives away from lamp
- Not recommended for dome lamp use
- U.S. Registered TM #3483147



Part Number	Lamp Connector	Plug Side 1	Plug Side 2	Lens Color	Lens Material	Volts	Amps
44347C	Hardwired	Hardwired	PL-3	Clear	PC	12	0.53

LED

SUPER 44

SUPER 44[®], LED, 6 DIODE, 4", FLANGE MOUNT, KIT



- Features robust, cost-effective, efficient design
- Surpasses back-up specifications with 1 lamp, eliminating 2 lamp systems
- Resembles Super 44 Series S/T/T lamp diode appearance for consistent look
- Epoxy-encapsulated with exclusive Fit 'N Forget™ plug assembly keeps corrosives away from lamp
- Not recommended for dome lamp use
- U.S. Registered TM #3483147

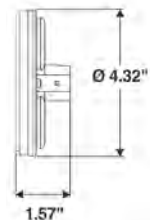

Part Number	Lamp Connector	Plug Side 1	Plug Side 2	Lens Color	Lens Material	Mount Color	Volts	Amps	Kit Includes	Diamond Shell
44180C	Fit 'N Forget S.S.	Fit 'N Forget S.S.	Female PL-2	Clear	PC	Black	12	0.24	44350C light, 40700 grommet 94789 plug	No
44183C	Fit 'N Forget S.S.	Fit 'N Forget S.S.	2 Position Plug	Clear	PC	Black	12	0.24	44350C light, 40700 grommet	No
44184C	Fit 'N Forget S.S.	Fit 'N Forget S.S.	Female PL-2	Clear	AC	Black	12	0.24	44990C light, 40700 grommet 94789 plug	Yes

LED

SUPER 44

LED
SUPER 44

SUPER 44®, LED, 6 DIODE, 4" , FLANGE MOUNT



- Features robust, cost-effective, efficient design
- Surpasses back-up specifications with 1 lamp, eliminating 2 lamp systems
- Resembles Super 44 Series S/T/T lamp diode appearance for consistent look
- Epoxy-encapsulated with exclusive Fit 'N Forget™ plug assembly keeps corrosives away from lamp
- Not recommended for dome lamp use
- U.S. Registered TM #3483147



Part Number	Lamp Connector	Lens Color	Lens Material	Mount Color	Volts	Amps	Diamond Shell
44344C	Fit 'N Forget S.S.	Clear	PC	Gray	12	0.53	No
44345C	Fit 'N Forget S.S.	Clear	PC	White	12	0.53	No
44346C	Fit 'N Forget S.S.	Clear	PC	Black	12	0.53	No
44991C	Fit 'N Forget S.S.	Clear	AC	Gray	12	0.53	Yes
44992C	Fit 'N Forget S.S.	Clear	AC	Black	12	0.53	Yes

LED
SUPER 44

SUPER 44®, LED, 6 DIODE, 4" , FLANGE MOUNT, HARDWIRED



- Features robust, cost effective, efficient design
- Surpasses back-up specifications with 1 lamp, eliminating 2 lamp systems
- Resembles Super 44 Series S/T/T lamp diode appearance for consistent look
- Epoxy-encapsulated with exclusive Fit 'N Forget™ plug assembly keeps corrosives away from lamp
- Not recommended for dome lamp use
- U.S. Registered TM #3483147



Part Number	Lamp Connector	Plug Side 1	Plug Side 2	Lens Color	Lens Material	Mount Color	Volts	Amps
44348C	Hardwired	Hardwired	Stripped End	Clear	PC	Black	12	0.53
44349C	Hardwired	Hardwired	Stripped End	Clear	PC	White	12	0.53

LED
SUPER 44

SUPER 44®, LED, 6 DIODE, 4" , FLANGE MOUNT, KIT



- Features robust, cost-effective, efficient design
- Surpasses back-up specifications with 1 lamp, eliminating 2 lamp systems
- Resembles Super 44 Series S/T/T lamp diode appearance for consistent look
- Epoxy-encapsulated with exclusive Fit 'N Forget™ plug assembly keeps corrosives away from lamp
- Not recommended for dome lamp use
- U.S. Registered TM #3483147



Part Number	Lamp Connector	Plug Side 1	Plug Side 2	Lens Color	Lens Material	Mount Color	Volts	Amps	Kit Includes
44181C	Fit 'N Forget S.S.	Fit 'N Forget S.S.	Female PL-2	Clear	PC	Gray	12	0.24	44344C light, 94789 plug
44182C	Fit 'N Forget S.S.	Fit 'N Forget S.S.	Female PL-2	Clear	PC	Black	12	0.24	44346C light, 94789 plug

SUPER 44[®], LED, 27 DIODE, 4", GROMMET MOUNT



- Most advanced and cost-effective 4" LED back-up lamps
- 27-LED pattern lamps require the purchase of two lamps, one for each side

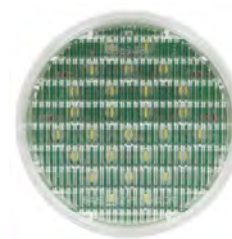

Part Number	Lamp Connector	Lens Color	Lens Material	Mount Color	Volts	Amps
44206C	Fit 'N Forget S.S.	Clear	PC		12	0.1

SUPER 44[®], LED, 27 DIODE, 4", GROMMET MOUNT, KIT



- Most advanced and cost-effective 4" LED back-up lamps
- 27-LED pattern lamps require the purchase of two lamps, one for each side
- 54-LED pattern lamps require the purchase of only 1 lamp



Part Number	Lamp Connector	Plug Side 1	Plug Side 2	Lens Color	Lens Material	Mount Color	Volts	Amps	Kit Includes	Diamond Shell
44041C	Fit 'N Forget S.S.	Fit 'N Forget S.S.	Female PL-2	Clear	PC	Black	12	0.1	44206C light, 40700 grommet	No
44141C	Fit 'N Forget S.S.	Fit 'N Forget S.S.	Female PL-2	Clear	AC	Black	12	0.1	40700 grommet, 94789 plug	Yes

SUPER 44[®], LED, 27 DIODE, 4", FLANGE MOUNT



- Most advanced and cost-effective 4" LED back-up lamps
- 27-LED pattern lamps require the purchase of two lamps, one for each side
- 54-LED pattern lamps require the purchase of only one lamp

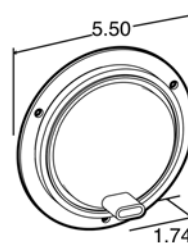

Part Number	Lamp Connector	Lens Color	Lens Material	Mount Color	Volts	Amps
44236C	Fit 'N Forget S.S.	Clear	PC	Gray	12	0.1
44239C	Fit 'N Forget S.S.	Clear	PC	White	12	0.1
44240C	Fit 'N Forget S.S.	Clear	PC	Black	12	0.1

LED
SUPER 44

SUPER 44[®], LED, 27 DIODE, 4", FLANGE MOUNT, KIT

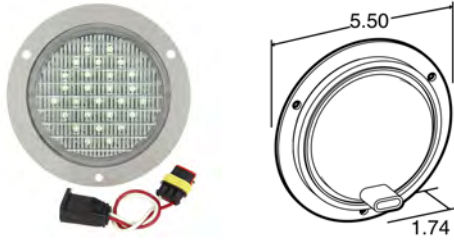

- Most advanced and cost-effective 4" LED Back-up lamps
- 27- LED pattern lamps require the purchase of two lamps, one for each side
- 54-LED pattern lamps require the purchase of only one lamp



Part Number	Lamp Connector	Plug Side 1	Plug Side 2	Lens Color	Lens Material	Mount Color	Volts	Amps	Kit Includes	Diamond Shell
44045C	Fit 'N Forget S.S.	Fit 'N Forget S.S.	Female PL-2	Clear	PC	Gray	12	0.1	44236C light, 94789 plug	No
44145C	Fit 'N Forget S.S.	Fit 'N Forget S.S.	Female PL-2	Clear	AC	Gray	12	0.1	94789 plug	Yes
44146C	Fit 'N Forget S.S.	Fit 'N Forget S.S.	Female PL-2	Clear	PC	Black	12	0.1	44240C light, 94789 plug	No

LED
SUPER 44

SUPER 44[®], LED, 54 DIODE, 4", GROMMET MOUNT

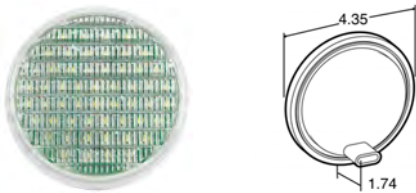

- Most advanced and cost-effective 4" LED Back-up lamps
- 27-LED pattern lamps require the purchase of two lamps, one for each side
- 54-LED pattern lamps require the purchase of only one lamp



Part Number	Lamp Connector	Lens Color	Lens Material	Mount Color	Volts	Amps
44205C	Fit 'N Forget S.S.	Clear	PC		12	0.13

LED
SUPER 44

SUPER 44[®], LED, 54 DIODE, 4", GROMMET MOUNT, KIT



- Most advanced and cost-effective 4" LED Back-up lamps
- 27-LED pattern lamps require the purchase of two lamps, one for each side
- 54-LED pattern lamps require the purchase of only one lamp



Part Number	Lamp Connector	Plug Side 1	Plug Side 2	Lens Color	Lens Material	Mount Color	Volts	Amps	Kit Includes
44040C	Fit 'N Forget S.S.	Fit 'N Forget S.S.	Female PL-2	Clear	PC	Black	12	0.13	44205C light, 40700 grommet

SUPER 44[®], LED, 54 DIODE, 4", FLANGE MOUNT



- Most advanced and cost-effective 4" LED Back-up lamps
- 27- LED pattern lamps require the purchase of two lamps, one for each side
- 54-LED pattern lamps require the purchase of only one lamp

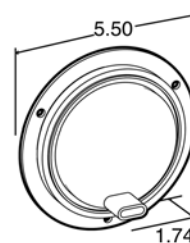

Part Number	Lamp Connector	Lens Color	Lens Material	Mount Color	Volts	Amps
44235C	Fit 'N Forget S.S.	Clear	PC	Gray	12	0.13

LED

SUPER 44

SUPER 44[®], LED, 54 DIODE, 4", FLANGE MOUNT, KIT



- Most advanced and cost-effective 4" LED Back-up lamps
- 27- LED pattern lamps require the purchase of two lamps, one for each side
- 54-LED pattern lamps require the purchase of only one lamp

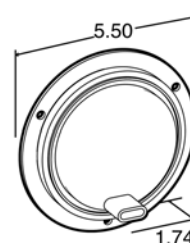

Part Number	Lamp Connector	Plug Side 1	Plug Side 2	Lens Color	Lens Material	Mount Color	Volts	Amps	Kit Includes
44044C	Fit 'N Forget S.S.	Fit 'N Forget S.S.	Female PL-2	Clear	PC	Gray	12	0.13	44235C light, 94789 plug

LED

SUPER 44

SIGNAL-STAT, LED, 24 DIODE, 4", GROMMET MOUNT, ROUND



- Popular on owner/operator show trucks
- Uses standard right-angle connection
- Unique LED array displays a full pattern light output design
- Epoxy-encapsulated electronics resist damage from moisture and corrosion
- Less current draw, resulting in increased battery and alternator life while allowing more power for other vehicle requirements
- Two lamps required for back-up
- LEDs do not have a filament, therefore are not susceptible to damage from shock and vibration

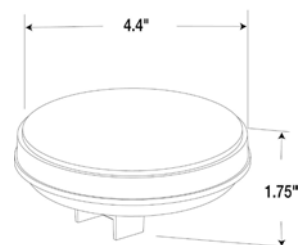

Part Number	Lamp Connector	Lens Color	Lens Material	Volts	Amps
4060C	PL-2	Clear	PC	12	0.13

LED

SIGNAL-STAT

SIGNAL-STAT, LED, 24 DIODE, 4", FLANGE MOUNT, ROUND

LED

SIGNAL-STAT

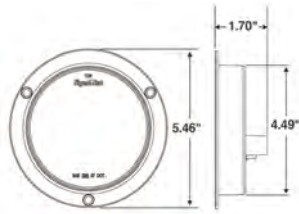

- Housing and flange are molded together to form one piece
- Uses standard right-angle PL-3 connection
- When properly mounted, exceeds FMVSS DOT requirements for back-up
- Unique LED array displays full pattern light output design
- Must be used as a two-lamp system for back-up
- Designed with impact-resistant polycarbonate
- LEDs do not have a filament, therefore are not susceptible to damage from shock and vibration
- Epoxy-encapsulated electronics resist damage from moisture and corrosion



Part Number	Lamp Connector	Lens Color	Lens Material	Mount Color	Volts	Amps
4063C	PL-3	Clear	PC	Gray	12	0.15

66® SERIES, LED, 1 DIODE, 2"x6", GROMMET MOUNT

LED

66 SERIES

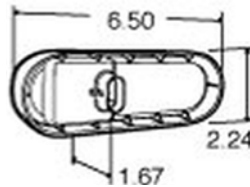

- Less current draw, resulting in increased battery and alternator life while allowing more power for other vehicle requirements
- Single-diode Technology
- Uses Fit 'N Forget™ connection for increased corrosion resistance
- Two lamps required for back-up
- Meets specifications for dome lamp applications
- Must be mounted vertically
- Patent No. - USA: 6811287, Canada: 2477643, Mexico: 250259, Australia: 2003208501



Part Number	Lamp Connector	Lens Color	Lens Material	Volts	Amps
66205C	Fit 'N Forget S.S.	Clear	PC	12	0.3

66® SERIES, LED, 1 DIODE, 2"x6", FLANGE MOUNT

LED

66 SERIES

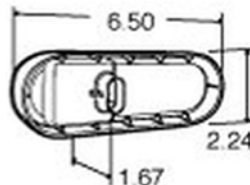

- Less current draw, resulting in increased battery and alternator life while allowing more power for other vehicle requirements
- Single-diode Technology
- Uses Fit 'N Forget™ connection for increased corrosion resistance
- Two lamps required for back-up
- Meets specifications for dome lamp applications
- Must be mounted vertically
- Patent No. - USA: 6811287, Canada: 2477643, Mexico: 250259, Australia: 2003208501



Part Number	Lamp Connector	Lens Color	Lens Material	Mount Color	Volts	Amps
66206C	Fit 'N Forget S.S.	Clear	PC	Black	12	0.3

SIGNAL-STAT, LED, 24 DIODE, 2"X6", GROMMET MOUNT, OVAL



- Popular on owner/operator show trucks
- Uses standard right-angle connection
- 24-diode pattern
- Unique LED array displays a full pattern light output design
- Epoxy-encapsulated electronics resist damage from moisture and corrosion
- Less current draw, resulting in increased battery and alternator life while allowing more power for other vehicle requirements
- LEDs do not have a filament, therefore are not susceptible to damage from shock and vibration
- Two lamps required for back-up
- Legal mounted horizontally or vertically

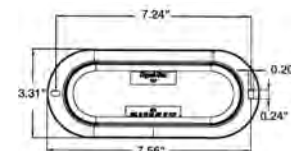

Part Number	Lamp Connector	Lens Color	Lens Material	Volts	Amps
6060C	PL-2	Clear	PC	12	0.25

SIGNAL-STAT, LED, 24 DIODE, 2"X6", FLANGE MOUNT, OVAL



- Housing and flange are molded together to form one piece
- Uses standard right-angle PL-2 connection
- When properly mounted, exceeds FMVSS DOT requirements for back-up
- Unique LED array displays full pattern light output design
- Must be used as a two-lamp system for back-up
- Designed with impact-resistant polycarbonate
- LEDs do not have a filament, therefore are not susceptible to damage from shock and vibration
- Epoxy-encapsulated electronics resist damage from moisture and corrosion
- 6063 can be legally mounted horizontally or vertically

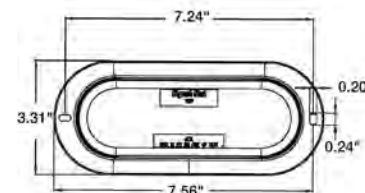

Part Number	Lamp Connector	Lens Color	Lens Material	Mount Color	Volts	Amps
6063C	PL-2	Clear	PC	Gray	12	0.25

SIGNAL-STAT, LED, 24 DIODE, 3"X5", GROMMET MOUNT, RECTANGULAR

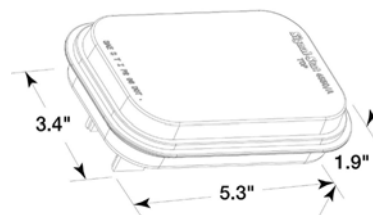

Part Number	Lamp Connector	Lens Color	Lens Material	Volts	Amps
4560C	PL-2	Clear	PC	12	0.18

40[®] SERIES, INCANDESCENT, 1 BULB, 4" , GROMMET MOUNT

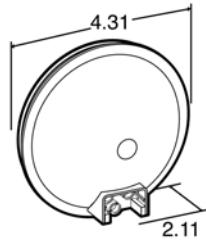

- Polycarbonate lens and housing are sonically sealed
- Bulb is shock-mounted for extended life
- Legal only for back-up function
- Not recommended for dome lamp use
- Replaces Signal-Stat 4041W and 4047W
- Upgrade to LED lighting systems using Truck-Lite's Super 44 series products



Part Number	Lamp Connector	Lens Color	Lens Material	Volts	Amps	Housing Color
40204	PL-2	Clear	PC	12	2.1	White
40206C	PL-2	Clear	PC	12	2.1	Clear
40212	PL-2	Clear	PC	24	1.02	White

40[®] SERIES, INCANDESCENT, 1 BULB, 4" , GROMMET MOUNT, KIT

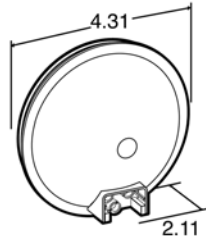

- Polycarbonate lens and housing are vibration sealed
- Bulb is shock-mounted for extended life
- Legal only for back-up function
- Not recommended for dome lamp use
- Replaces Signal-Stat 4041W and 4047W
- Upgrade to LED lighting systems using Truck-Lite's Super 44 series products



Part Number	Lamp Connector	Plug Side 1	Plug Side 2	Lens Color	Lens Material	Mount Color	Volts	Amps	Kit Includes
40004	PL-2	PL-2	Stripped End/ Ring Terminal	Clear	PC	Black	12	2.1	40204 light, 40700 grommet, 94922 plug
40012	PL-2	PL-2	Stripped End/ Ring Terminal	Clear	PC	Black	24	2.1	40700 grommet, 94922 plug
40306	Socket Assembly	Socket Assembly	Stripped End/ Ring Terminal	Clear	PC	Black	12	2.1	99010C light, 40700 grommet



Quick Tip: Plug Side 1 vs. Plug Side 2

When buying a plug for your light it's important to understand what type of connection mates with the light and what type of termination will mate with the power harness. Plug Side 1 refers to the side of the plug that mates directly to the light. Plug Side 2 refers to the end of the plug that will mate with the power source.



40[®] SERIES, INCANDESCENT, 1 BULB, 4", FLANGE MOUNT



- Polycarbonate lens and housing are sonically sealed
- Bulb is shock-mounted for extended life
- Legal only for back-up function
- Not recommended for dome lamp use
- Replaces Signal-Stat 4041W and 4047W
- Upgrade to LED Lighting Systems using Truck-Lite's Super 44 series Products

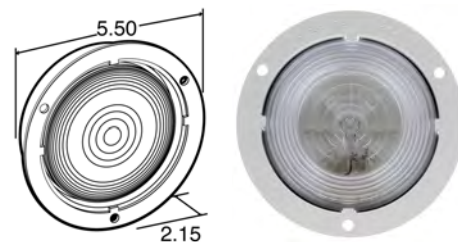

Part Number	Lamp Connector	Lens Color	Lens Material	Mount Color	Volts	Amps
40224	PL-2	Clear	PC	Gray	12	2.1
40262	PL-2	Clear	PC	Black	12	2.1

INCANDESCENT

40 SERIES

40[®] SERIES, INCANDESCENT, 27 DIODE, 4", FLANGE MOUNT, KIT



- Polycarbonate lens and housing are vibration sealed
- Bulb is shock-mounted for extended life
- Legal only for back-up function
- Not recommended for dome lamp use
- Replaces Signal-Stat 4041W and 4047W
- Upgrade to LED Lighting Systems using Truck-Lite's super 44 Series Products

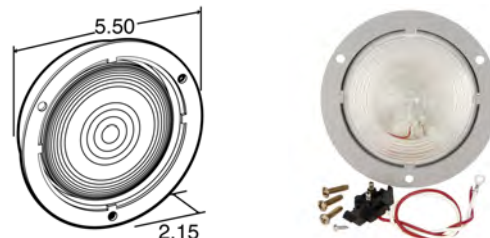

Part Number	Lamp Connector	Plug Side 1	Plug Side 2	Lens Color	Lens Material	Mount Color	Volts	Amps	Kit Includes
40024	PL-2	PL-2	Stripped End/ Ring Terminal	Clear	PC	Gray	12	2.1	40224 light, 94922 plug
40071	PL-2	PL-2	Stripped End/ Ring Terminal	Clear	PC	Black	12	2.1	40262 light 94992 plug

INCANDESCENT

40 SERIES

Keep Your Connections Safe. Don't Forget Your Dielectric Gel.

Dielectric gel protects your lights by protecting the points of contact between elements of your lighting and harness system. Our dielectric compounds prevent arcing and corrosion and keep your lights performing as they should.

You can find our dielectric products on page 498



INCANDESCENT

SUPER 40

SUPER 40®, INCANDESCENT, 1 BULB, 4", GROMMET MOUNT

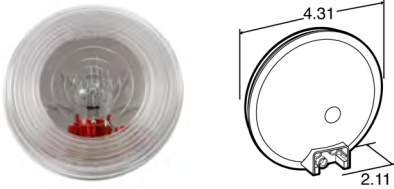

- Uniquely designed shock mount extends lamp life
- Sealed polycarbonate lens and housing resist heat and impact
- Flange and flush-mount grommets designed for mounting in a 4-1/2" hole
- Not recommended for dome lamp use
- Two lamps required to meet federal lighting regulations
- Upgrade to LED lighting systems using Truck-Lite's Super 44 series products



Part Number	Lamp Connector	Lens Color	Lens Material	Volts	Amps
40244	PL-2	Clear	PC	12	2.1

INCANDESCENT

SUPER 40

SUPER 40®, INCANDESCENT, 1 BULB, 4", GROMMET MOUNT, KIT

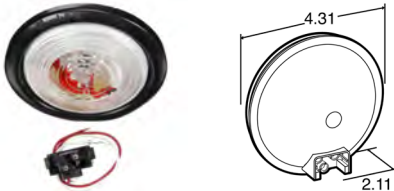

- Uniquely designed shock mount extends lamp life
- Sealed polycarbonate lens and housing resist heat and impact
- Flange and flush mount grommets designed for mounting in a 4-1/2" hole
- Not recommended for dome lamp use
- Two lamps required to meet federal lighting regulations
- Upgrade to LED lighting systems using Truck-Lite's Super 44 series products



Part Number	Lamp Connector	Plug Side 1	Plug Side 2	Lens Color	Lens Material	Mount Color	Volts	Amps	Kit Includes
40044	PL-2	PL-2	Stripped End/ Ring Terminal	Clear	PC	Black	12	2.1	40244 light, 40700 grommet, 94992 plug

INCANDESCENT

SUPER 40

SUPER 40®, INCANDESCENT, 1 BULB, 4", FLANGE MOUNT



- Uniquely designed shock mount extends lamp life
- Sealed polycarbonate lens and housing resist heat and impact
- Flange and flush mount grommets designed for mounting in a 4-1/2" hole
- Not recommended for dome lamp use
- Two lamps required to meet federal lighting regulations
- Upgrade to LED lighting systems using Truck-Lite's Super 44 series products



Part Number	Lamp Connector	Lens Color	Lens Material	Mount Color	Volts	Amps
40260	PL-2	Clear	PC	Black	12	2.14
40261	PL-2	Clear	PC	Gray	12	2.14

45[®] SERIES, INCANDESCENT, 1 BULB, 3"x5", GROMMET MOUNT, KIT, REFLECTORIZED



- Direct replacement for approved lamps on United States Postal Service L.L.V. (Long Life Vehicle)
- Designed for mounting on a 7 - 11 degree rollback from the vertical plane
- Three versions: each features turn and hazard functions, stop and tail functions or back-up functions

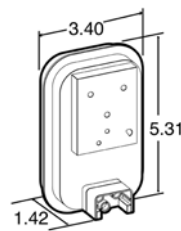

Part Number	Lamp Connector	Plug Side 1	Plug Side 2	Lens Color	Lens Material	Mount Color	Volts	Amps	Kit Includes
45024	PL-2	Right Angle PL-2	Packard Connector 12020398	Clear	PC	White	12	2.1	45701 grommet, 60701 grommet

INCANDESCENT

45 SERIES

SUPER 45[®], INCANDESCENT, 1 BULB, 3"x5", GROMMET MOUNT, REFLECTORIZED

- Heavy-duty bulb for longer life
- Mount horizontally or vertically

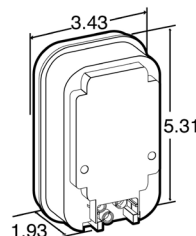

Part Number	Lamp Connector	Lens Color	Lens Material	Mount Color	Volts	Amps
45204	PL-2	Clear	PC	Black	12	2.1

INCANDESCENT

SUPER 45

SUPER 45[®], INCANDESCENT, 1 BULB, 3"x5", GROMMET MOUNT, KIT, REFLECTORIZED



- Mount horizontally or vertically
- Heavy-duty, dual filament cartridge bulb
- Unique shock mount absorbs shock and vibration

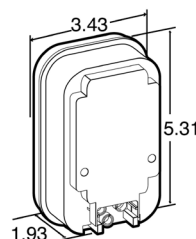

Part Number	Lamp Connector	Plug Side 1	Plug Side 2	Lens Color	Lens Material	Mount Color	Volts	Amps	Kit Includes
45004	PL-2	Right Angle PL-2	Stripped End/ Ring Terminal	Clear	PC	Black	12	2.1	45204 light, 45700 grommet, 94992 plug

INCANDESCENT

SUPER 45

60[®] SERIES, INCANDESCENT, 1 BULB, 2"X6", GROMMET MOUNT

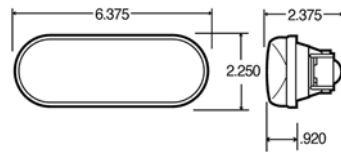

- High-impact polycarbonate lens and housing are sonically sealed
- Heavy-duty, shock mounted bulb
- Legal mounted vertically or horizontally
- Only one lamp required to meet federal lighting regulations
- Not recommended for dome lamp use
- Replaces Signal-Stat 4071W
- Upgrade to LED lighting systems using Truck-Lite's 66 Series products



Part Number	Lamp Connector	Lens Color	Lens Material	Volts	Amps
60284C	PL-2	Clear	PC	12	2.1

60[®] SERIES, INCANDESCENT, 1 BULB, 2"X6", GROMMET MOUNT, KIT,

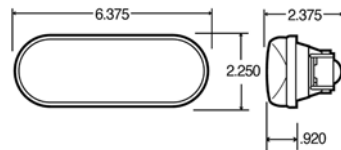

- High-impact polycarbonate lens and housing are sonically sealed
- Heavy-duty, shock mounted bulb
- Legal mounted vertically or horizontally
- Only one lamp required to meet federal lighting regulations
- Not recommended for dome lamp use
- Replaces Signal-Stat 4071W
- Upgrade to LED lighting systems using Truck-Lite's 66 Series products



Part Number	Lamp Connector	Plug Side 1	Plug Side 2	Lens Color	Lens Material	Mount Color	Volts	Amps	Kit Includes
60004C	PL-2	PL-2	Stripped End/ Ring Terminal	Clear	PC	Black	12	2.1	60204C light, 60700 grommet, 94922 plug
60345C	Socket Assembly	Socket Assembly	Stripped End/ Ring Terminal	Clear	PC	Black	12	2.1	99184C light, 60700 grommet, 95415 plug

60[®] ECONOMY, INCANDESCENT, 1 BULB, 2"X6", GROMMET MOUNT



- Vibration welded lens and housing
- Shock-mounted bulb to extend life
- Legal mounted horizontally or vertically
- Only one lamp required to meet federal lighting regulations
- Not recommended for dome lamp use
- Upgrade to LED lighting systems using Truck-Lite's 66 Series products

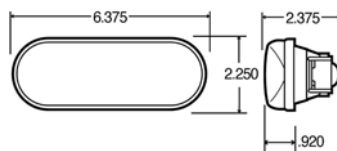

Part Number	Lamp Connector	Lens Color	Lens Material	Volts	Amps
60284C	PL-2	Clear	PC	12	2.1

INCANDESCENT

60 ECONOMY

60[®] ECONOMY, INCANDESCENT, 1 BULB, 2"X6", GROMMET MOUNT, KIT



- Vibration welded lens and housing
- Shock-mounted bulb to extend life
- Legal mounted horizontally or vertically
- Only one lamp required to meet federal lighting regulations
- Not recommended for dome lamp use
- Upgrade to LED lighting systems using Truck-Lite's 66 Series products

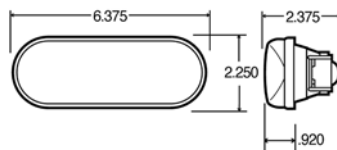

Part Number	Lamp Connector	Plug Side 1	Plug Side 2	Lens Color	Lens Material	Mount Color	Volts	Amps	Kit Includes
60092C	PL-2	PL-2	Stripped End/ Ring Terminal	Clear	PC	Black	12	2.1	60284C light, 60700 grommet, 94992 plug

INCANDESCENT

60 ECONOMY

80 SERIES, INCANDESCENT, 1 BULB, 4" ROUND, BRACKET MOUNT, 2 SCREW, KIT



- Features rubber body which helps absorb shock and vibration
- Can be used as back-up or utility lamp
- Requires two lamps to meet federal Lighting Regulations as a back-up lamp
- Not recommended for dome lamp use

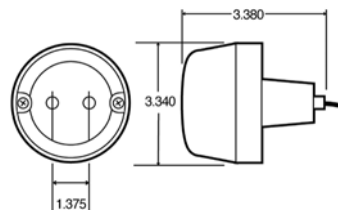

Part Number	Lamp Connector	Plug Side 1	Plug Side 2	Lens Color	Lens Material	Mount Color	Volts	Amps	Kit Includes
80340	Hardwired	Hardwired	Blunt Cut	Clear	AC	Black	12	2.1	99095C lens

INCANDESCENT

80 SERIES

80 SERIES, INCANDESCENT, 1 BULB, 4", BRACKET MOUNT, KIT

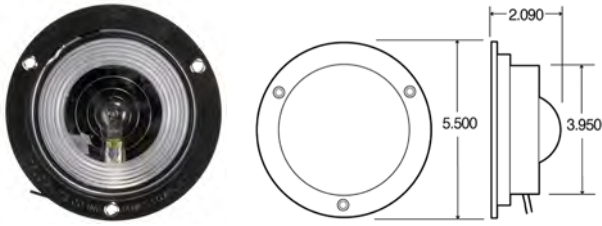

- Features rubber body which helps absorb shock and vibration
- Can be used as back-up or utility lamp
- Requires two lamps to meet federal lighting regulations as a back-up lamp
- Not recommended for dome lamp use



Part Number	Lamp Connector	Plug Side 1	Plug Side 2	Lens Color	Lens Material	Mount Color	Volts	Amps	Kit Includes
80304	Hardwired	Hardwired	Stripped End	Clear	PC	Black	12	2.1	97945 seal

80 SERIES, INCANDESCENT, 1 BULB, 4", FLANGE MOUNT, KIT

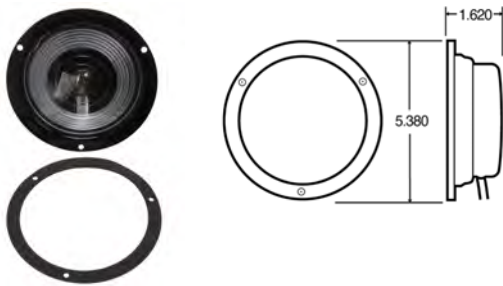

- Features flush-mount housing with recessed lens
- Snap-in retaining ring holds lens in place
- Available in three finishes - black painted steel, stainless steel or polished stainless steel
- Model 80342 requires two lamps to meet federal lighting regulations
- Replaces Signal-Stat 4111W
- Upgrade to LED lighting systems using Truck-Lite's Super 44 series products



Part Number	Lamp Connector	Plug Side 1	Plug Side 2	Lens Color	Lens Material	Mount Color	Volts	Amps
80342	Hardwired	Hardwired	Blunt Cut	Clear	PC	Black	12	2.1
80344	Hardwired	Hardwired	Blunt Cut	Clear	PC	Gray	12	2.1
80345	Hardwired	Hardwired	Blunt Cut	Clear	PC	Silver	12	2.1

INCANDESCENT, 1 BULB, 4", GROMMET MOUNT, ROUND

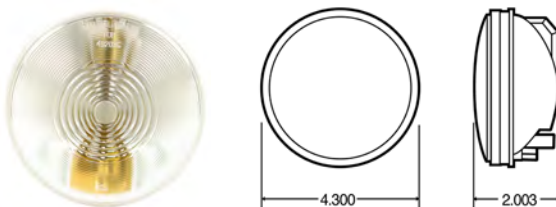

- Features male pin connections
- High-impact polycarbonate lens and housing
- Shock mount resists road shock and vibration
- Two lamps required to meet federal lighting regulations
- Not recommended for dome lamp use
- Replaces Grote #62211
- Upgrade to LED lighting systems using Truck-Lite's Super 44 series products



Part Number	Lamp Connector	Lens Color	Lens Material	Volts	Amps
49203C	PL-2	Clear	PC	12	2.1

INCANDESCENT, 1 BULB, 4", GROMMET MOUNT, ROUND, KIT



- Features male pin connections
- High-impact polycarbonate lens and housing
- Shock mount resists road shock and vibration
- Two lamps required to meet federal lighting regulations
- Not recommended for dome lamp use
- Replaces Grote #62211
- Upgrade to LED lighting systems using Truck-Lite's Super 44 series products

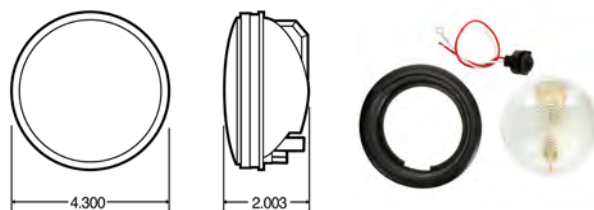

Part Number	Lamp Connector	Plug Side 1	Plug Side 2	Lens Color	Lens Material	Mount Color	Volts	Amps	Kit Includes
49003C	PL-2	Straight PL-2	Stripped End/Ring Terminal	Clear	PC	Black	12	2.1	49203C light, 40700 grommet, 96107 plug

INCANDESCENT

1 BULB

SIGNAL-STAT, INCANDESCENT, 1 BULB, 4", FLANGE MOUNT



- Narrow depth behind flange allows lamp to fit where other lamps cannot
- Mounts through 4-1/2" dia. cutout, 2" depth below flange
- Upgrade to Truck-Lite LED lighting systems using Super 44 products

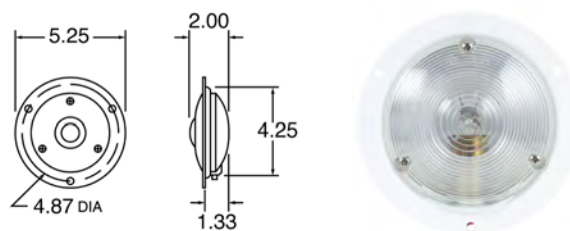

Part Number	Lamp Connector	Plug Side 1	Plug Side 2	Lens Color	Lens Material	Mount Color	Volts	Amps	Shock Mount Y/N
3613W	Hardwired	Hardwired	Stripped End	Clear	PC	Chrome	12	2.1	Y
3691W	Hardwired	Hardwired	Stripped End	Clear	PC	White	12	2.1	N
3693W	Hardwired	Hardwired	Stripped End	Clear	PC	Chrome	12	2.1	N

INCANDESCENT

1 BULB

SIGNAL-STAT, INCANDESCENT, 1 BULB, 4", 4 SCREW BRACKET MOUNT



- Heavy-duty, economical and efficient
- Allows one light instead of two to comply with back-up lamp regulations
- Polycarbonate twist-off lens and O-ring seal
- Black plate housing: heavy gauge anodized aluminum with staked tubular bulb socket and waterproof grommet on exit wire

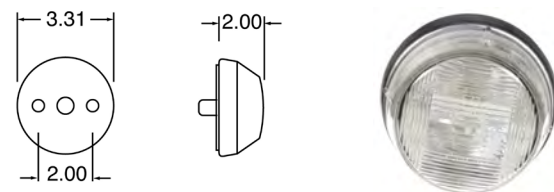

Part Number	Lamp Connector	Plug Side 1	Plug Side 2	Lens Color	Lens Material	Mount Color	Volts	Amps
92WD	Hardwired	Hardwired	Stripped End	Clear	PC	Silver	12	2.1

INCANDESCENT

1 BULB

INCANDESCENT, 1 BULB, 2"X6", GROMMET MOUNT, RECTANGULAR

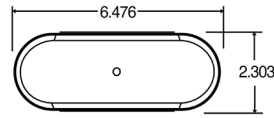
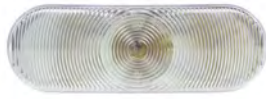

- Features male pin connections
- High-impact polycarbonate lens and housing
- Shock mount resists road shock and vibration
- Two lamps required to meet federal lighting regulations
- Not recommended for dome lamp use
- Replaces Grote #62241



Part Number	Lamp Connector	Lens Color	Lens Material	Volts	Amps
69203C	PL-2	Clear	PC	12	2.1

INCANDESCENT, 1 BULB, 2"X6", GROMMET MOUNT, RECTANGULAR, KIT

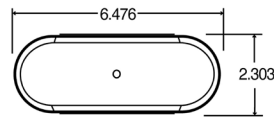

- Features male pin connections
- High-impact polycarbonate lens and housing
- Shock mount resists road shock and vibration
- Two lamps required to meet federal lighting regulations
- Not recommended for dome lamp use
- Replaces Grote #62211
- Upgrade to LED lighting systems using Truck-Lite's Super 44 series products



Part Number	Lamp Connector	Plug Side 1	Plug Side 2	Lens Color	Lens Material	Mount Color	Volts	Amps	Kit Includes
69003C	PL-2	Straight PL-2	Stripped End/Ring Terminal	Clear	PC	Black	12	2.1	69203C light, 60700 grommet, 96108 plug

INCANDESCENT, 1 BULB, 4"X6", 4 SCREW BRACKET MOUNT, RECTANGULAR

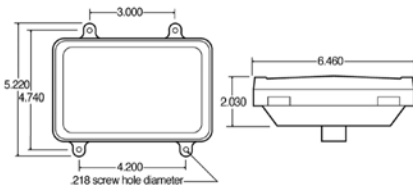

- Polycarbonate lens and housing are sealed
- Bulb socket cams-in for ease of repair/replacement (sold separately)
- Recess mounts using two screws at 3.0" centers and two screws at 4.2" centers



Part Number	Lamp Connector	Lens Color	Lens Material	Mount Color	Volts	Amps
07082C	3 Blade Terminals	Clear	PC	Clear	12	2.1
07096C	Socket Assembly	Clear	PC	White		

Looking for even more product information?

Visit truck-lite.com



**Powerful Search
Function**



**360° Product
Images**



**Easy-To-Find
Replacement
Parts**